

GRUNDIG

GUD1500 Digital Box
Instruction Manual

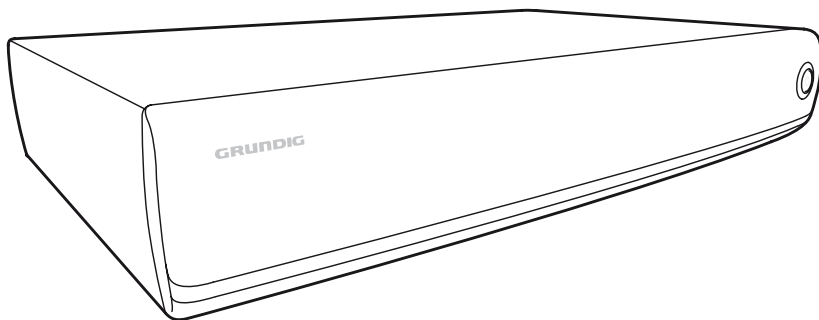

**IMPORTANT: Please read all instructions
carefully before use and keep for future reference.**

Digital TV

**Thank you for choosing this Grundig Digital Box.
Not only can it receive over 50 Freeview channels, you can also listen to digital radio all at the touch of a button.**

IMPORTANT: Use of any electrical equipment should be undertaken with care. Please read the safety section on page 17-18 before using your Digital Box. This appliance is for household use only.



A Digital Box lets you access the free digital channels that are broadcast in the UK. It uses a digital signal, received through your normal aerial and lets you watch it through your existing television.



A FREEVIEW Digital Box gives you over 50 digital TV channels and up to 24 digital radio stations, without a subscription or contract. For more information on FREEVIEW, and to check reception in your area please visit www.freeview.co.uk

What's in the box?

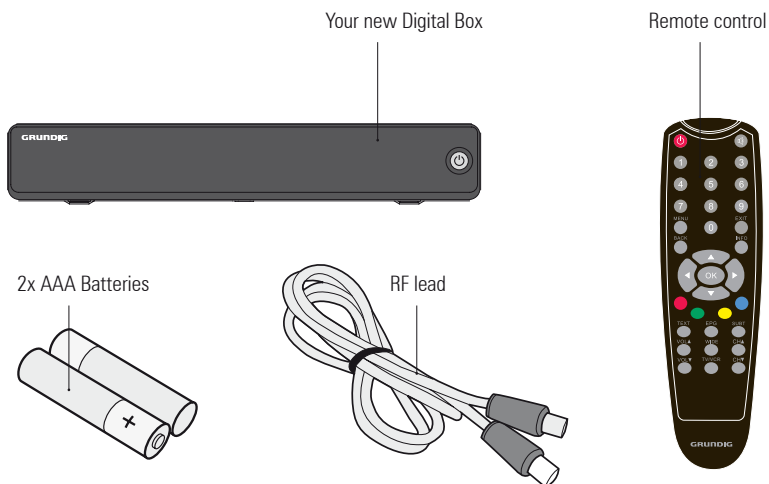

Other things you will need

Roof top aerial

It is recommended that you use a wideband rooftop aerial in order for your Digital Box to work properly. For more information see the Quick Start guide or visit www.digitaluk.co.uk.

Scart cable

You **will** need a Scart cable to connect between your Digital Box and your TV. If you want to connect a DVD recorder to your Digital Box, you will need an additional Scart cable.

Contents

01	Your Digital Box.....	4	06	Advanced features.....	11-13
02	Your remote control.....	5	07	Re-tuning.....	14
03	Connecting up.....	6	08	Troubleshooting.....	15
04	Getting started.....	7	09	Specifications.....	16
05	Using your Digital Box ...	8-10			

Front panel

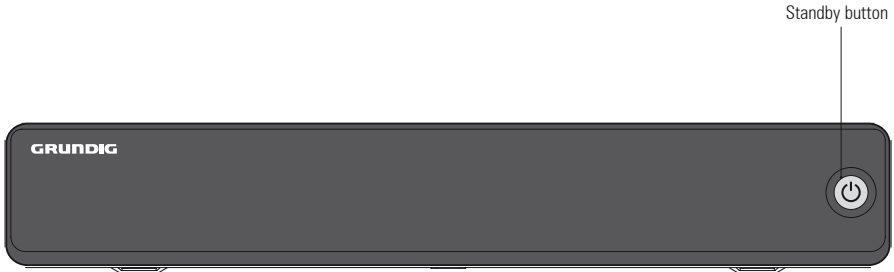

Rear panel

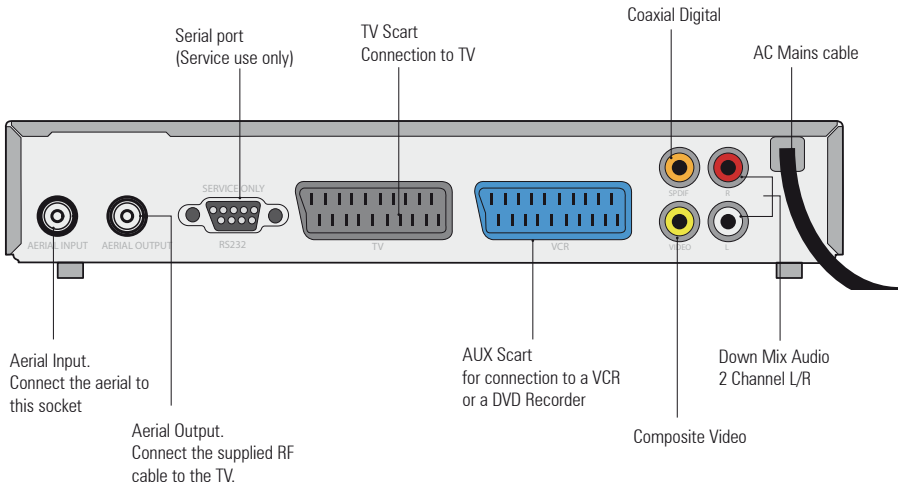

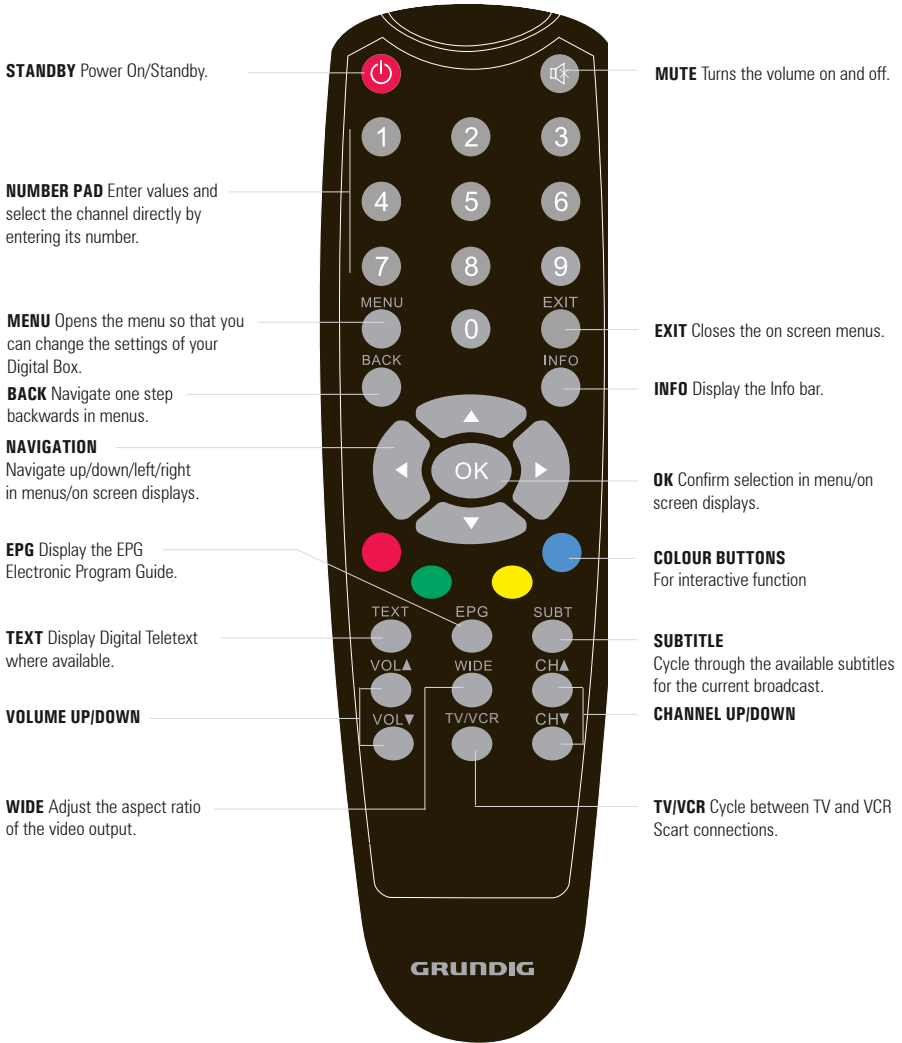

Getting connected

Connecting to the TV with SCART

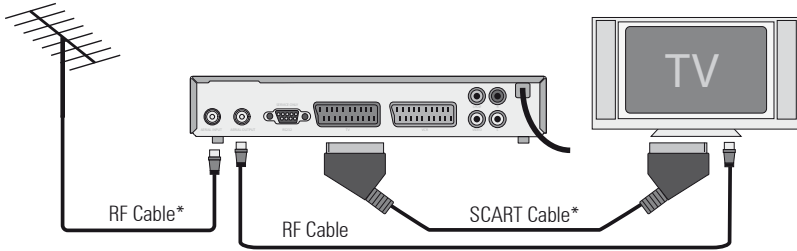

Other connections

Connecting to the TV and DVD recorder with SCART

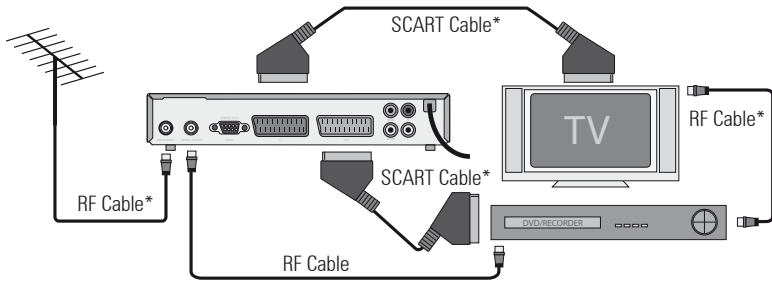

Connecting a Hi-Fi system

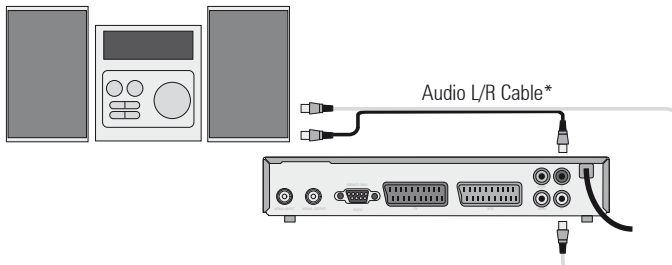

* Not included in the box

1

Install batteries in remote

Remove the battery cover. Insert two size AAA batteries so that the '+' and '-' marks on the batteries match the '+' and '-' marks inside the unit. Replace the battery cover.

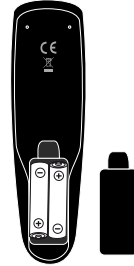

2

Plug in and switch on

Insert the Digital Box mains plug into a mains socket. Switch your TV on.



3

The Easy install screen

The first time installation screen will appear on screen. Select the aspect ratio (screen size), using ► (the up and down arrow buttons) to move between the options: NORMAL and WIDESCREEN.

Press **OK**. The Digital Box will automatically begin to tune.

The scan progress screen will be displayed, showing you how many channels have been found and saved. The tuning may take several minutes to complete. When the search is complete, your Digital Box is ready to use. The programme at the top of the channel list will be shown on your TV when the search is complete.



As with most of your electrical goods, there will be functions you use everyday, and others that you need only occasionally. We've put the most commonly used functions in this section so you can get your Digital Box up and running as quickly as possible.

We suggest you read this section carefully, then use the other sections to dip in to whenever you need some extra details or some guidance for settings.

Using the EPG

The Electronic Programme Guide, or EPG, is an on-screen TV guide. It shows all scheduled programmes seven days in advance for every tuned in channel. Press the **EPG** button on the remote control to access the guide.



You can use the **▲▼** buttons to select a different channel. Press **OK** to watch the selected channel, the EPG window will close automatically.

You can view the EPG as a timeline, as shown above, or as a daily schedule, shown below.

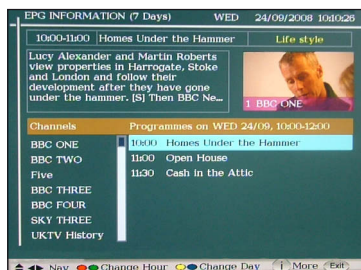

Press the **MENU** button to switch to the daily schedule EPG view. Press the blue button to move to the next day's schedule and the yellow button to move to the previous.

You can also use the red button to move the guide backwards two hours, and the green button to go forwards two hours.

Your EPG also contains digital radio channels. These are usually saved to the higher numbers, starting around channel 700.

Changing the channel

You can select the channel you want to watch by using the **CH ▲** and **CH ▼** buttons on the remote control.

Alternatively use the number buttons to key in the channel number.

When you change the channel the Info bar will be displayed for a few seconds. This shows details of the currently showing and the next programme for the selected channel.

Changing the volume

You can change the volume of your Digital Box by using the **VOL ▲** and **VOL ▼** buttons on the remote control. **VOL ▲** will increase the volume and **VOL ▼** will decrease the volume. To turn the volume off, press the mute button on the remote control. To turn it back on, press the mute button again.

Using subtitles

To use subtitles, press the **SUBT** button on the remote control. When subtitles have been turned on the screen below will be shown and the subtitle text will start to display on screen.

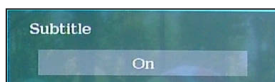

DON'T FORGET! Subtitles are only shown when they are broadcast with the programme. Not all programmes have subtitles.

Using digital text

Many digital channels also provide digital text. For example this could be information about programmes, the weather, news and many other topics.

To use digital text, press the **TEXT** button on the remote control. An example is shown below.



DON'T FORGET! Not all channels have digital text.

The info banner

The info banner can be accessed when you are watching a TV programme, by pressing the **INFO** button.



The info banner gives you date, time and signal strength information, and also shows you details of the programme you are watching and the programme following it.

Setting a reminder

You can set your TV to remind you when a programme you want to watch is about to start.

- 1 Press the **EPG** button.
- 2 Scroll to the programme you want to be reminded about using the arrow buttons.
- 3 Press the **OK** button.



- 4 The reminder has now been set. Press the **EXIT** button to go back to the programme you were watching.
- 5 When the reminder time has been reached a pop up box will appear.

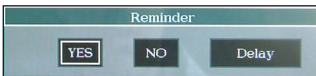

Using the left and right arrow keys choose 'YES' to go to the programme, 'NO' to delete the reminder, or 'DELAY' to remind you again in a few minutes. Press the **OK** button to confirm.

- 6 If a reminder clashes with the start time of a reminder already set, a warning pop up window will be shown.

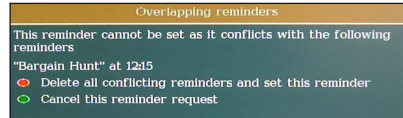

Press the red button to delete the old reminder and replace it with the new one, or press the green button, to cancel the new reminder and keep the existing one.

Organising your channels

You can lock, skip, delete and move channels in your channel list.

- 1 Press the **MENU** button.

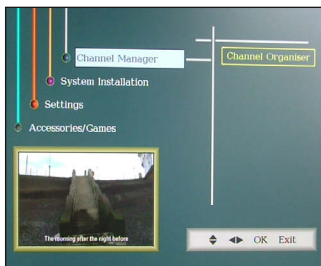

- 2 Select 'Channel Organiser' and then press the **OK** button.

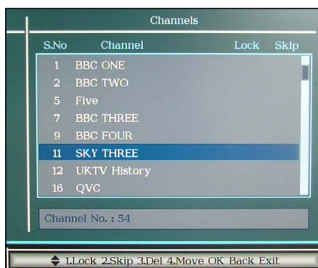

- 3 The channel list will be shown. From this menu you can press **1** to lock a channel, press **2** to skip a channel, press **3** to delete a channel and press **4** to move a channel.

DON'T FORGET! You can re-tune your Digital Box to retrieve channels you have deleted. See Re-tuning on page 14.

The settings menu

The settings menu lets you alter the default settings of your Digital Box.

- 1 Press the **MENU** button.
- 2 Select 'Settings' and then press the **OK** button. The settings menu has two sub menus, 'System Setup' and 'Factory Default'.

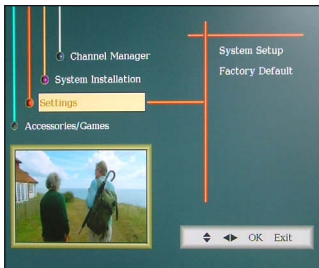

- 3 System Setup has two sub menus, 'OSD & TV' and 'Parental Lock'. Press the right arrow button to select the right hand column.

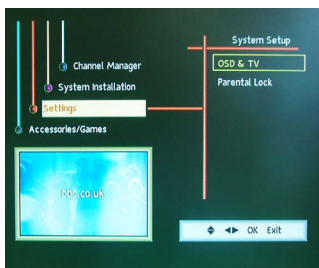

- 4 Use the up and down arrows on the remote control to select each option, then use the left and right arrows to change the setting so that it best suits your setup.

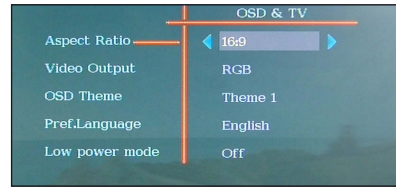

- 5 The Parental Lock is used so that you can set an age restriction on the content that is allowed to be viewed.

DON'T FORGET! You can also change the passcode to a different number in this menu.

- 6 To reset your Digital Box to the original factory settings, select the 'Factory Default' menu.

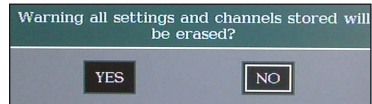

- 7 Select 'YES' and then press **OK**. Your Digital Box will now reset all the default settings and re-tune all channels.

Low power mode

Low power mode reduces the amount of electricity that your Digital Box uses.

To put your Digital Box in low power mode change the setting to 'On'

DON'T FORGET! When the Digital Box is in low power mode, the Scart loop through is deactivated and can not be used.

The accessories and games menu

From this menu you can play games, upgrade your Digital Box and find out information about your Digital Box.

- 1 Press the **MENU** button.

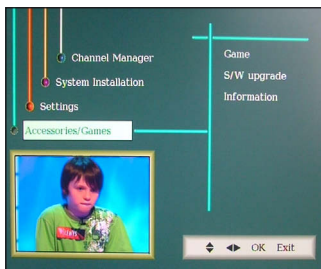

- 2 To play the games, access the 'Game' menu. You have a choice of two games, Snake and Tetris.

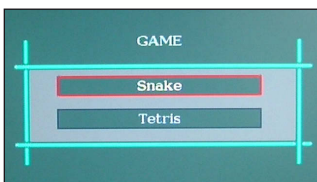

Use the arrow buttons on the remote control to play the games, following the instructions on screen. To exit games, press the **EXIT** button.

- 3 'S/W Upgrade' will search for updated software for your Digital Box. If new software is available it will be downloaded and installed.

DON'T FORGET! Updating the software on your Digital Box, will use all of the factory default settings, and cancel any reminders that you have set.

- 4 The 'Information' window gives you information about your Digital Box. It is useful to have this information when contacting the call centre for help.

Information	
H/W VERSION	: 5180vL0
S/W VERSION	: A2FST0U_19_000B
Date	: 06/09/2008
Time	: 16:35:58
Model Number	: 1500
Subtitle Status	: OFF
Language Status	: English
No of Channel	: 53
HelpLine Number	: 0871 230 1777
Transmitter Name	: Tacolneston
Exit	

DON'T FORGET! The information shown on your screen may be different to the one shown above.

Retuning your Digital Box

As digital switchover happens in your region, and extra channels and services are launched, you will need to retune your Digital Box.

- 1 Press the **MENU** button.
- 2 Select 'System Installation' and then press the **OK** button.
- 3 Select 'Auto Scan' and then press the **OK** button.

DON'T FORGET! If you have set your parental code you will need to enter it to retune your Digital Box.

- 4 The first time installation screen will appear on screen. Select the aspect ratio (screen size), using (the up and down arrow buttons) to move between the options: **NORMAL** and **WIDESCREEN**.

Press **OK**. The Digital Box will automatically begin to tune.

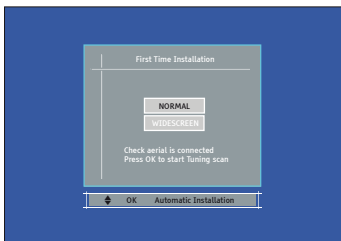

- 5 The tuning progress screen will be displayed, showing you how many channels have been found and saved. Scanning may take several minutes to complete.

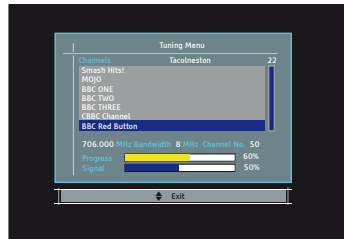

- 6 Your Digital Box has now been retuned.

Please note indoor aerial are not recommended for use with this product (this includes loft aerials) otherwise you may experience problems with reception or picture break ups on some channels.

Problem	Possible cause	What to do
Standby light not lit	Mains lead unplugged Mains fuse blown	Check mains lead Check fuse
No signal found	Aerial is disconnected Aerial is damaged/misaligned Out of digital signal area	Check aerial lead Check aerial Ensure that you are capable of receiving Digital TV
No picture or sound	Tuned to digital teletext channel	Switch to another channel
Scrambled channel message	Channel is scrambled	This Digital Box is not able to decode scrambled channels
No response to remote control	Digital Box is switched off Handset not aimed correctly Front panel obstructed Remote batteries exhausted	Plug in and turn on plug Aim remote at the front panel Check for obstructions in front of the Digital Box Replace the remote batteries
Forgotten PIN code		Contact the helpline
You have moved your TV and you find you are no longer able to receive digital channels	The aerial feed maybe sent through a distribution system which can/may reduce the digital signal now received by the Digital Box	Try a signal booster or a direct feed from the aerial

Need extra help?

Don't worry we are just the other end of the phone. If you're experiencing problems using your new product, before returning it to the retailer just call 0871 230 1777 or visit www.grundig.co.uk

Need a spare part?

In the unlikely event of requiring spare parts, please contact our spare parts department on: 0871 230 0790

Tuner and channel	<ul style="list-style-type: none"> • RF input connector (IEC-TYPE, IEC169-2, female) • RF output connector (IEC-TYPE, IEC169-2, male) • Frequency range: 470MHz ~862MHz (UHF)
Decoder <ul style="list-style-type: none"> • Transport stream • Profile level • Input rate • Video format • Audio format • Video output 	<p>MPEG-2 ISO/IEC 13818</p> <p>MAX. 15Mbit/s</p> <p>MPEG-2 Main profile @main level</p> <p>4:3/16:9 Switchable</p> <p>MPEG Layer I & II, 32 / 44.1 / 48KHz</p> <p>RGB, CVBS</p>
Connection <ul style="list-style-type: none"> • Main power cable • Tuner • Video • Audio • Data port 	<p>Fixed type</p> <p>Antenna input</p> <p>Composite video output, twin scart</p> <p>Stereo audio output, digital coaxial audio output</p> <p>RS-232 (for service use only)</p>
Power supply <ul style="list-style-type: none"> • Input voltage • Power consumption 	<p>AC 230V ~50Hz</p> <p>MAX. 8W/standby <2W</p>

IMPORTANT: Due to continual revision and improvements to our products design, specifications are subject to change without notice.

Electrical Information

This Digital Box is fitted with a BS1363/A 13 amp plug. If it is not suitable for your supply sockets it must be removed and replaced with an appropriate plug. If the plug becomes damaged and/or needs to be replaced please follow the wiring instructions below. The plug removed must be disposed of immediately. It must not be plugged into a supply socket as this will be an electrical hazard. If the fuse needs to be replaced it must be of the same rating and ASTA approved to BS1362. If the plug is changed, a fuse of the appropriate rating must be fitted in the plug, adapter or at the distribution board. If the fuse in a moulded plug is replaced, the fuse cover must be refitted before the appliance can be used.

Wiring Instructions

The supply cable will be either 2-core or 3-core. Follow the appropriate wiring instructions given below. In both cases ensure that the outer sheath of the cable is firmly held by the cable clamp.

2- Core plug

⚠ WARNING: Do not connect either wire to the earth terminal.



This symbol indicates that this 2-core appliance is Class II and does not require an earth connection.

The wire coloured blue must be connected to the terminal marked with the letter N or coloured black.

The wire coloured brown must be connected to the terminal marked with the letter L or coloured red.

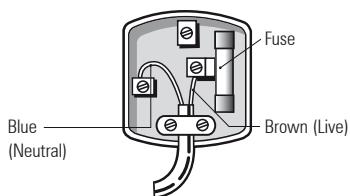

3- Core plug

⚠ WARNING: This appliance must be earthed.

The wire coloured green and yellow must be connected to the terminal marked with the letter E, or by the earth symbol (⏚), or coloured green or green and yellow.

The wire coloured blue must be connected to the terminal marked with the letter N or coloured black.

The wire coloured brown must be connected to the terminal

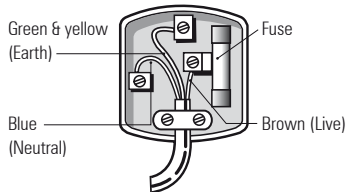

Warnings

- Unqualified attempts to repair this Digital Box will invalidate the warranty.
- Refer repairs to this Digital Box to a qualified service personnel only.
- Do not disassemble this Digital Box.
- There are dangerous-voltage parts inside that may cause electric shock even after power is disconnected.
- Store your Digital Box in a clean, dry environment.
- Unplug the Digital Box immediately if it gets wet, and consult a servicing technician.
- Always unplug the Digital Box before cleaning it.
- Wipe dust off the cabinet of the Digital Box with a clean, dry and soft cloth.
- Do not place any objects on top of the Digital Box.
- Avoid exposing your Digital Box directly to sunlight or other heat sources.
- Put your Digital Box in a well-ventilated area away from high humidity.
- Do not expose this Digital Box to rain or moisture, dripping or splashing.
- For stubborn stains use a damp (not dripping) cloth.
- Do not use any cleaning solutions on this Digital Box.

Safety Tips

If smoke, abnormal noise or odour comes out of this Digital Box, unplug from the mains supply immediately and contact the retailer. Never try to repair the Digital Box on your own. Always contact the dealer for repairs.

Note

This manual contains for-reference-only graphics and information that are subject to change without notice.

WEEE



This appliance is labelled in accordance with European Directive 2002/96/EG concerning used electrical and electronic appliances (waste electrical and electronic equipment - WEEE). The guideline determines the framework for the return and recycling of used appliances as applicable throughout the EU.

